

V_{DS}	20	V
$R_{DS(on) max}$ (@ $V_{GS} = 4.5V$)	0.99	m Ω
(@ $V_{GS} = 2.5V$)	1.50	
Q_g (typical)	155	nC
R_G (typical)	1.3	Ω
I_D (@ $T_{mb} = 25^\circ C$)	100 [Ⓞ]	A

HEXFET[®] Power MOSFET

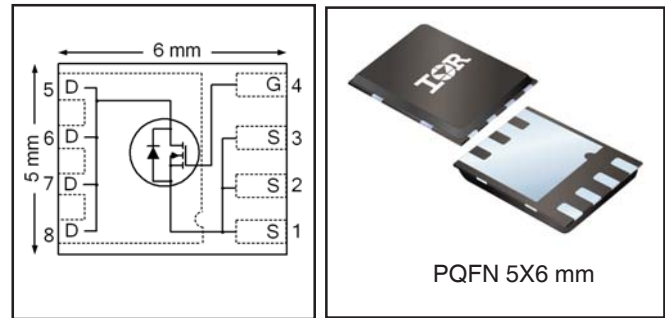

Applications

- Charge and discharge switch for battery application
- Load switch for 12V (typical) bus
- Hot-Swap Switch

Features

Low $R_{DS(on)}$ ($\leq 0.99m\Omega$)
Low Thermal Resistance to PCB ($\leq 0.8^\circ C/W$)
Low Profile (≤ 0.9 mm)
Industry-Standard Pinout
Compatible with Existing Surface Mount Techniques
RoHS Compliant, Halogen-Free

Benefits

Lower Conduction Losses
Enable better thermal dissipation
Increased Power Density
Multi-Vendor Compatibility
Easier Manufacturing
Environmentally Friendlier

results in
⇒

Base Part Number	Package Type	Standard Pack		Orderable part number	Note
		Form	Quantity		
IRFH6200PbF	PQFN 5mm x 6mm	Tape and Reel	4000	IRFH6200TRPbF	EOL Notice #259
	PQFN 5mm x 6mm	Tape and Reel	400	IRFH6200TR2PbF	

Absolute Maximum Ratings

	Parameter	Max.	Units
V_{DS}	Drain-to-Source Voltage	20	V
V_{GS}	Gate-to-Source Voltage	± 12	
$I_D @ T_A = 25^\circ C$	Continuous Drain Current, $V_{GS} @ 4.5V$	49	A
$I_D @ T_A = 70^\circ C$	Continuous Drain Current, $V_{GS} @ 4.5V$	40	
$I_D @ T_{mb} = 25^\circ C$	Continuous Drain Current, $V_{GS} @ 4.5V$	100 [Ⓞ]	
$I_D @ T_{mb} = 100^\circ C$	Continuous Drain Current, $V_{GS} @ 4.5V$	100 [Ⓞ]	
I_{DM}	Pulsed Drain Current ^①	400	
$P_D @ T_A = 25^\circ C$	Power Dissipation ^②	3.6	W
$P_D @ T_{mb} = 25^\circ C$	Power Dissipation ^③	156	
	Linear Derating Factor ^⑤	0.029	W/ $^\circ C$
T_J T_{STG}	Operating Junction and Storage Temperature Range	-55 to +150	$^\circ C$

Notes ^① through ^⑥ are on page 8

Static @ T_J = 25°C (unless otherwise specified)

	Parameter	Min.	Typ.	Max.	Units	Conditions
BV _{DSS}	Drain-to-Source Breakdown Voltage	20	—	—	V	V _{GS} = 0V, I _D = 250μA
ΔBV _{DSS} /ΔT _J	Breakdown Voltage Temp. Coefficient	—	6.4	—	mV/°C	Reference to 25°C, I _D = 1mA
R _{DS(on)}	Static Drain-to-Source On-Resistance	—	0.75	0.95	mΩ	V _{GS} = 10V, I _D = 50A ③
		—	0.80	0.99		V _{GS} = 4.5V, I _D = 50A ③
		—	1.10	1.50		V _{GS} = 2.5V, I _D = 50A ③
V _{GS(th)}	Gate Threshold Voltage	0.5	0.8	1.1	V	V _{DS} = V _{GS} , I _D = 150μA
ΔV _{GS(th)}	Gate Threshold Voltage Coefficient	—	-6.6	—	mV/°C	
I _{DSS}	Drain-to-Source Leakage Current	—	—	1.0	μA	V _{DS} = 16V, V _{GS} = 0V
		—	—	150		V _{DS} = 16V, V _{GS} = 0V, T _J = 125°C
I _{GSS}	Gate-to-Source Forward Leakage	—	—	100	nA	V _{GS} = 12V
	Gate-to-Source Reverse Leakage	—	—	-100		V _{GS} = -12V
g _{fs}	Forward Transconductance	260	—	—	S	V _{DS} = 10V, I _D = 50A
Q _g	Total Gate Charge	—	155	230	nC	V _{DS} = 10V
Q _{gs}	Gate-to-Source Charge	—	22	—		V _{GS} = 4.5V
Q _{gd}	Gate-to-Drain Charge	—	53	—		I _D = 50A (See Fig.17 & 18)
R _G	Gate Resistance	—	1.3	—	Ω	
t _{d(on)}	Turn-On Delay Time	—	14	—	ns	V _{DD} = 10V, V _{GS} = 4.5V
t _r	Rise Time	—	74	—		I _D = 50A
t _{d(off)}	Turn-Off Delay Time	—	140	—		R _G = 1.0Ω
t _f	Fall Time	—	160	—		See Fig.15
C _{iss}	Input Capacitance	—	10890	—	pF	V _{GS} = 0V
C _{oss}	Output Capacitance	—	2890	—		V _{DS} = 10V
C _{rss}	Reverse Transfer Capacitance	—	2180	—		f = 1.0MHz

Avalanche Characteristics

	Parameter	Typ.	Max.	Units
E _{AS}	Single Pulse Avalanche Energy ②	—	780	mJ
I _{AR}	Avalanche Current ①	—	30	A

Diode Characteristics

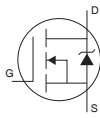
	Parameter	Min.	Typ.	Max.	Units	Conditions
I _S	Continuous Source Current (Body Diode)	—	—	100	A	MOSFET symbol showing the integral reverse p-n junction diode. 
I _{SM}	Pulsed Source Current (Body Diode) ①	—	—	400		
V _{SD}	Diode Forward Voltage	—	—	1.2	V	T _J = 25°C, I _S = 50A, V _{GS} = 0V ③
t _{rr}	Reverse Recovery Time	—	86	130	ns	T _J = 25°C, I _F = 50A, V _{DD} = 10V
Q _{rr}	Reverse Recovery Charge	—	350	525	nC	di/dt = 260A/μs ③

Thermal Resistance

	Parameter	Typ.	Max.	Units
R _{θJC-mb}	Junction-to-Mounting Base	0.5	0.8	°C/W
R _{θJC} (Top)	Junction-to-Case ④	—	15	
R _{θJA}	Junction-to-Ambient ⑤	—	35	
R _{θJA} (<10s)	Junction-to-Ambient ⑤	—	22	

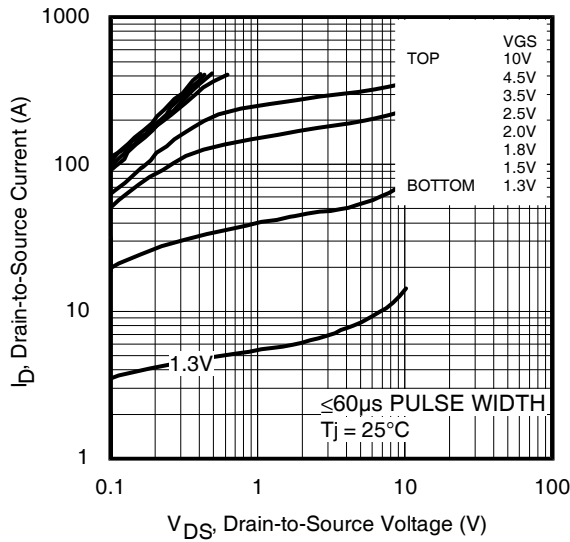
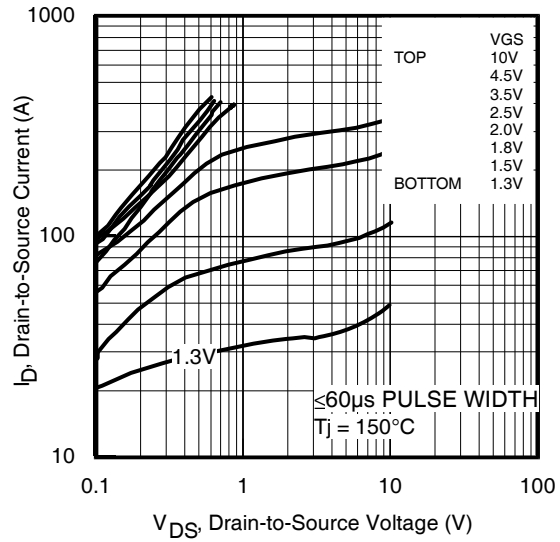
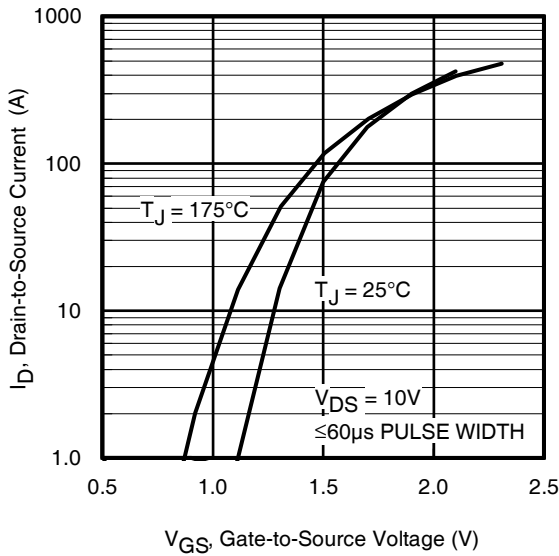
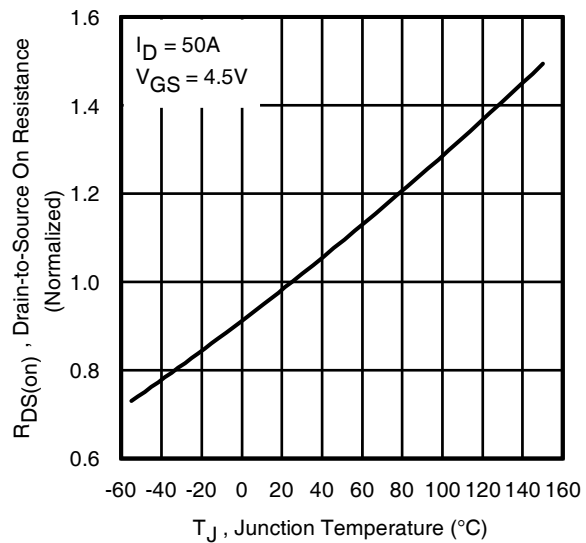
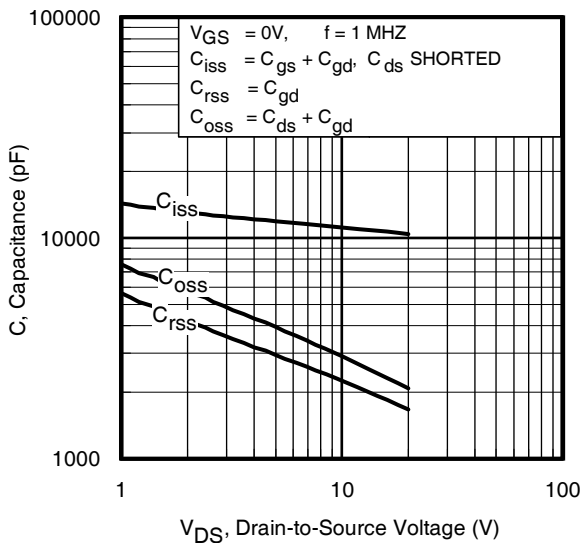
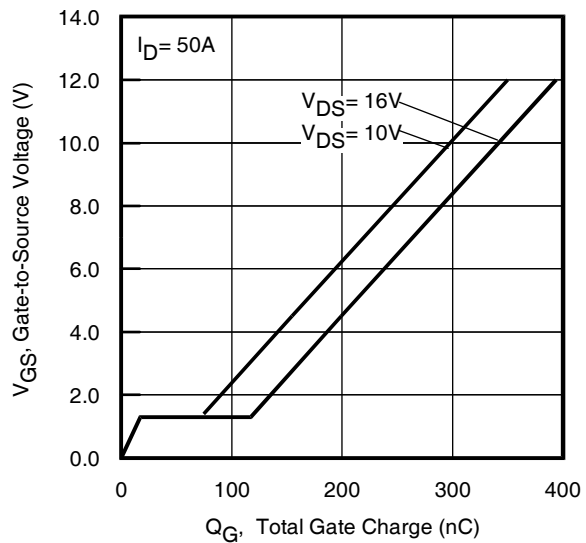
Fig 1. Typical Output Characteristics

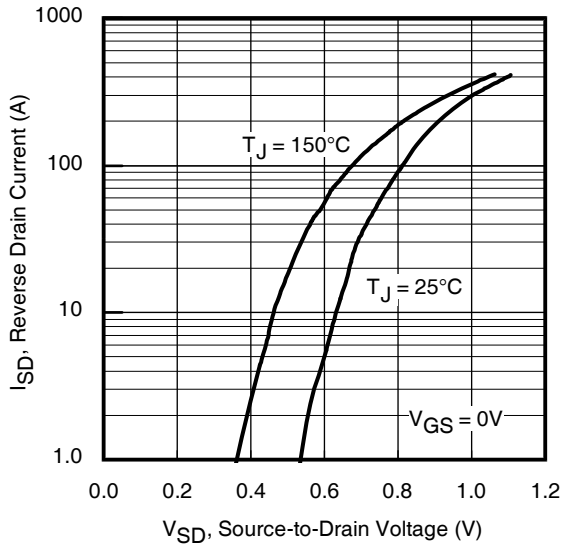
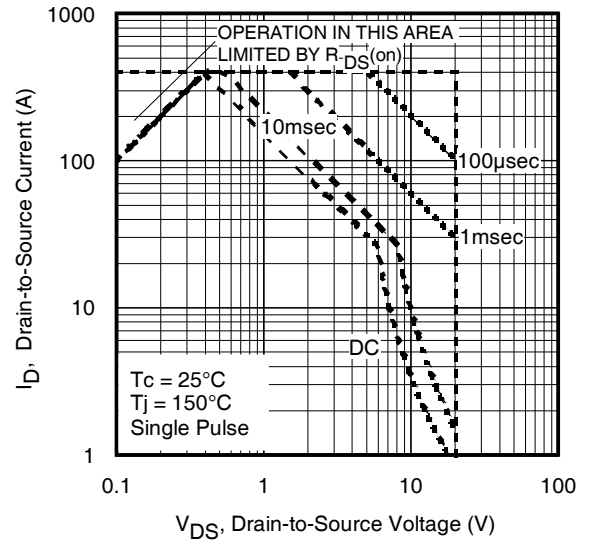
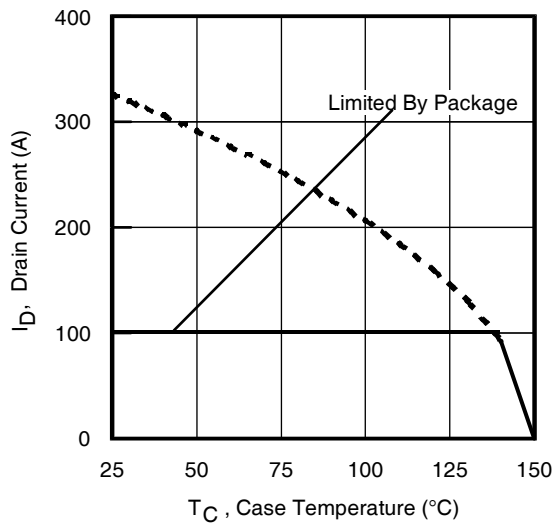
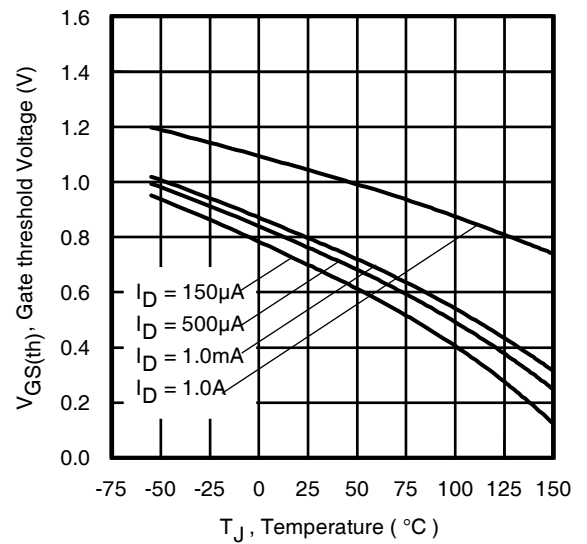
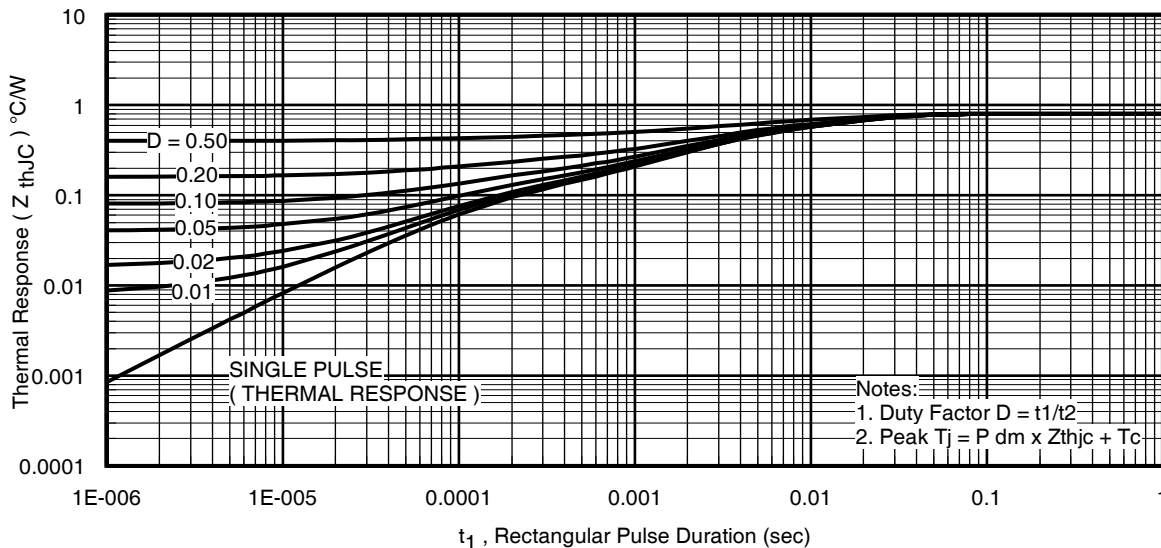
Fig 2. Typical Output Characteristics

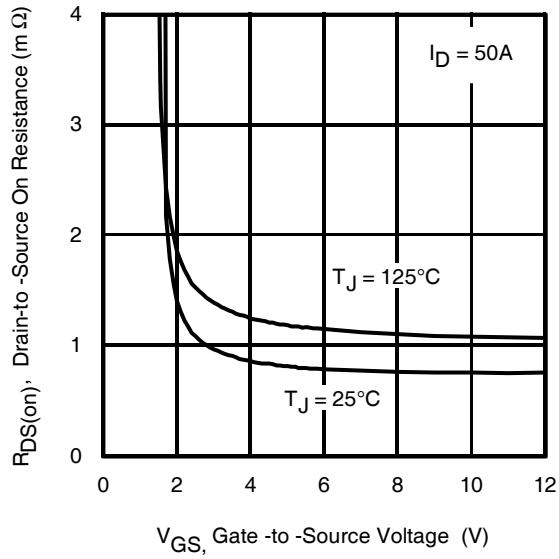
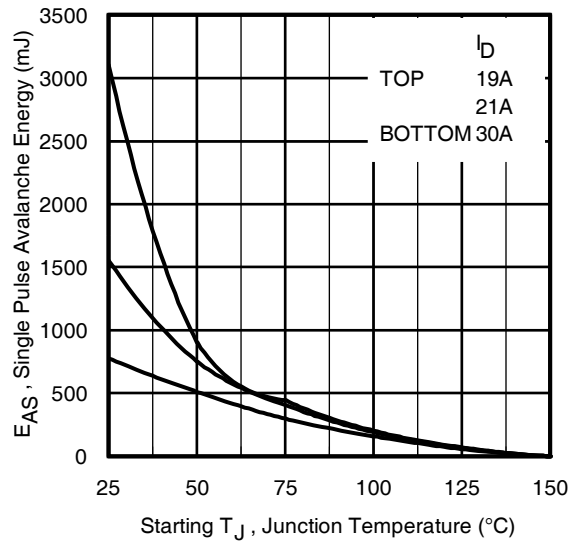
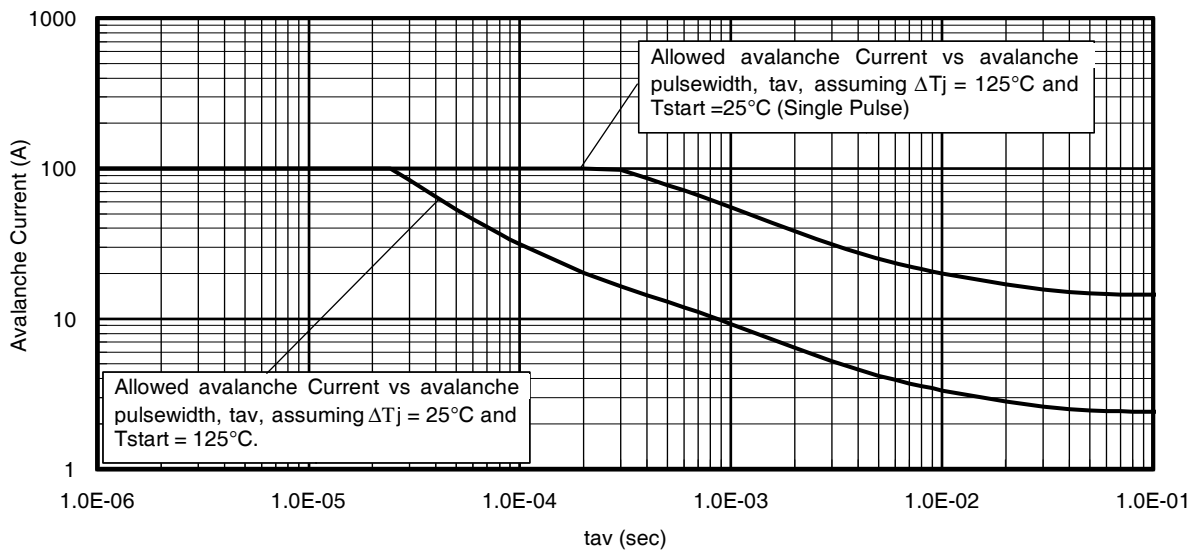
Fig 3. Typical Transfer Characteristics

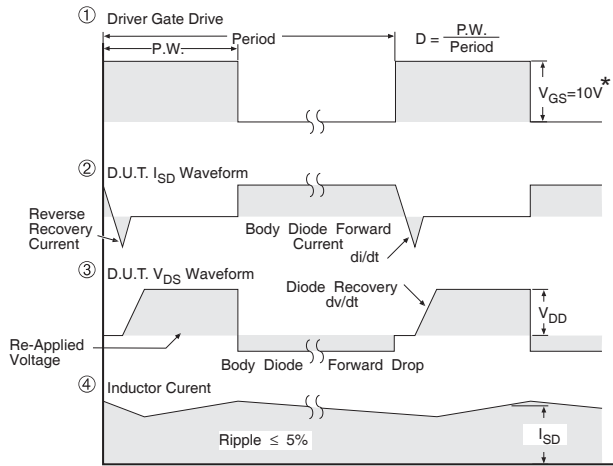
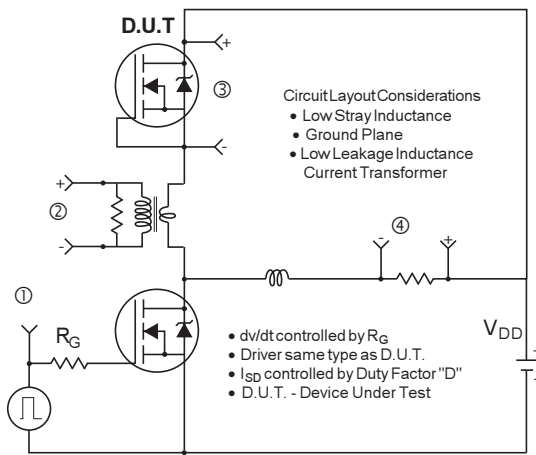
Fig 4. Normalized On-Resistance vs. Temperature

Fig 5. Typical Capacitance vs. Drain-to-Source Voltage

Fig 6. Typical Gate Charge vs. Gate-to-Source Voltage

Fig 7. Typical Source-Drain Diode Forward Voltage

Fig 8. Maximum Safe Operating Area

Fig 9. Maximum Drain Current vs. Case Temperature

Fig 10. Threshold Voltage vs. Temperature

Fig 11. Maximum Effective Transient Thermal Impedance, Junction-to-Mounting Base

Fig 12. On-Resistance vs. Gate Voltage

Fig 13. Maximum Avalanche Energy vs. Drain Current

Fig 14. Typical Avalanche Current vs. Pulsewidth



* $V_{GS} = 5V$ for Logic Level Devices

Fig 15. Peak Diode Recovery dv/dt Test Circuit for N-Channel HEXFET® Power MOSFETs

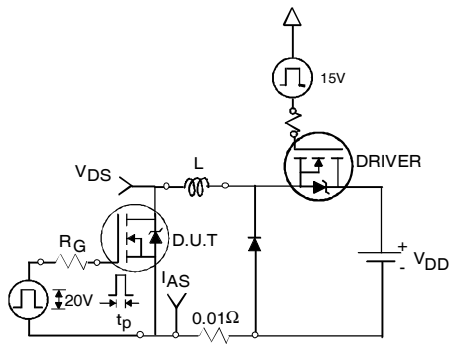

Fig 16a. Unclamped Inductive Test Circuit

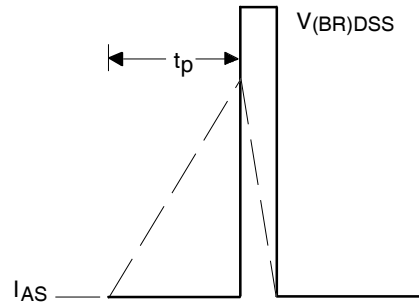

Fig 16b. Unclamped Inductive Waveforms

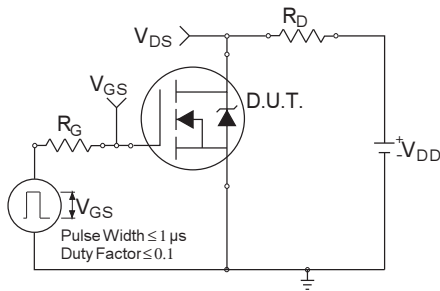

Fig 17a. Switching Time Test Circuit

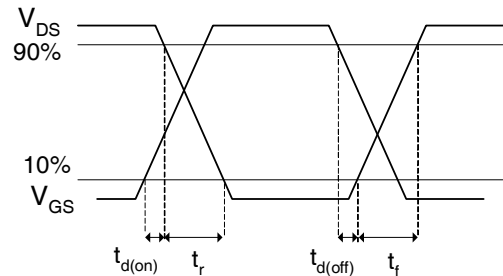

Fig 17b. Switching Time Waveforms

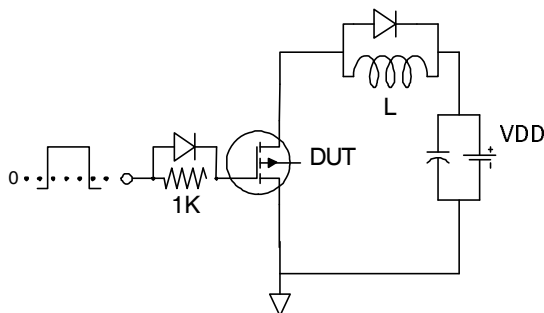

Fig 18a. Gate Charge Test Circuit

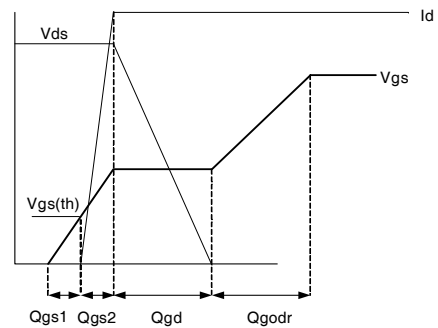
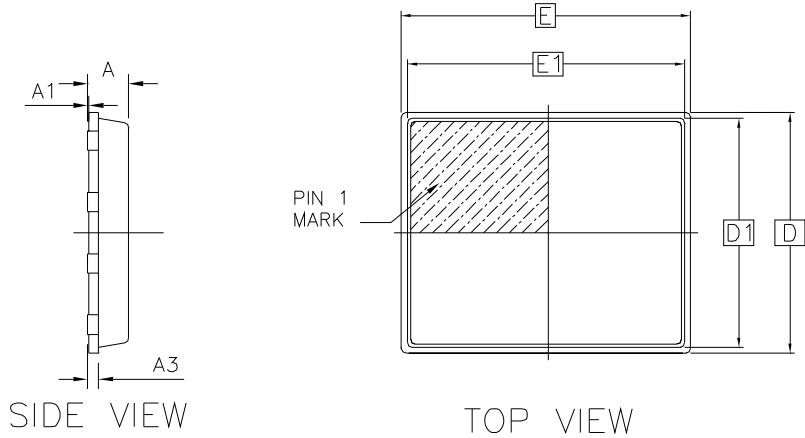
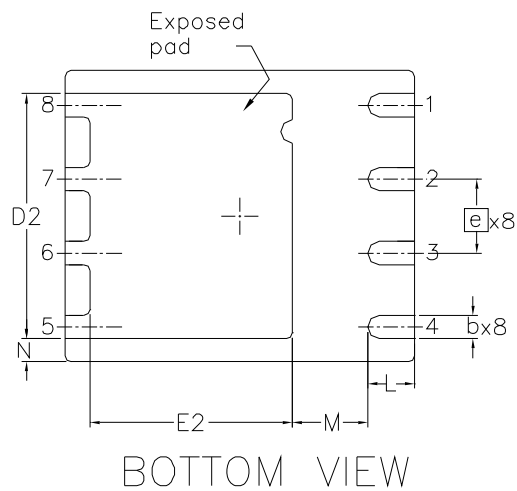

Fig 18b. Gate Charge Waveform

PQFN 5x6 Outline "B" Package Details



OUTLINE PQFN 5x6B			
DIM SYMBOL	MIN	NOM	MAX
A	0.80	0.83	0.90
A1	0	0.020	0.05
A3		0.20	REF
b	0.35	0.40	0.47
D		5.00	BSC
D1		4.75	BSC
D2	4.10	4.21	4.30
e		1.27	BSC
E		6.00	BSC
E1		5.75	BSC
E2	3.38	3.48	3.58
L	0.70	0.80	0.90
M		1.30	REF
N		0.40	REF



For more information on board mounting, including footprint and stencil recommendation, please refer to application note AN-1136:

<http://www.irf.com/technical-info/appnotes/an-1136.pdf>

For more information on package inspection techniques, please refer to application note AN-1154:

<http://www.irf.com/technical-info/appnotes/an-1154.pdf>

PQFN 5x6 Outline "B" Part Marking

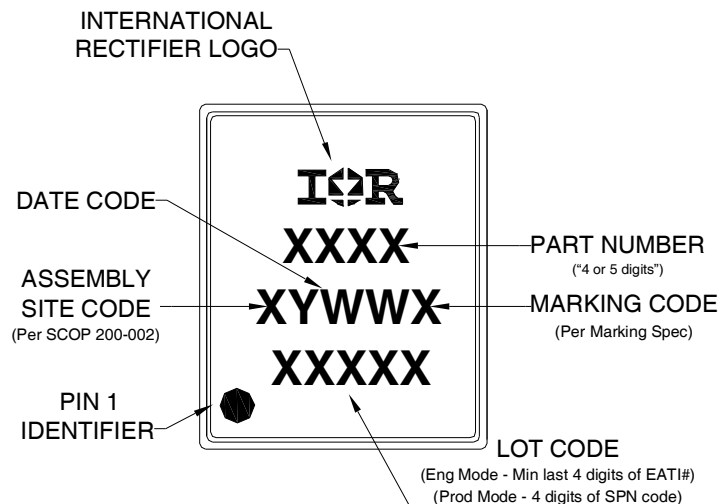

Note: For the most current drawing please refer to IR website at: <http://www.irf.com/package/>

PQFN 5x6 Outline "B" Tape and Reel

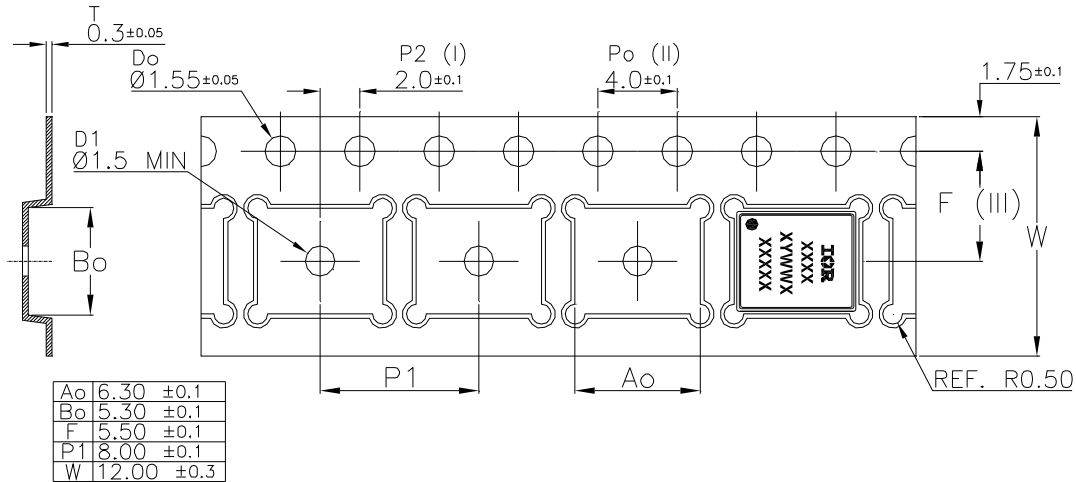

Note: For the most current drawing please refer to IR website at: <http://www.irf.com/package/>

Qualification information[†]

Qualification level	Industrial (per JEDEC JESD47F ^{††} guidelines)	
Moisture Sensitivity Level	PQFN 5mm x 6mm	MSL1 (per JEDEC J-STD-020D ^{††})
RoHS compliant	Yes	

[†] Qualification standards can be found at International Rectifier's web site
<http://www.irf.com/product-info/reliability>

^{††} Applicable version of JEDEC standard at the time of product release.

Revision History

Date	Comments
1/28/2013	• Improve the R _{dson} at 4.5V max from 1.2mOhm to 0.99mOhm.
12/02/2014	• Added R _{dson} 10V (Absolute Maximum Rating table still based on R _{dson} max at 4.5V gate drive voltage) on page 1 & 2. • Formatted the data sheet using the IR Corporate template. • Updated ordering information to reflect the End-Of-Life (EOL) of the mini-reel option (EOL notice #259)

Notes:

- ① Repetitive rating; pulse width limited by max. junction temperature.
- ② Starting T_J = 25°C, L = 1.7mH, R_G = 25Ω, I_{AS} = 30A.
- ③ Pulse width ≤ 400μs; duty cycle ≤ 2%.
- ④ R_θ is measured at T_J of approximately 90°C.
- ⑤ When mounted on 1 inch square 2 oz copper pad on 1.5x1.5 in. board of FR-4 material.
- ⑥ Calculated continuous current based on maximum allowable junction temperature. Package is limited to 100A by production test capability.